

Sezione verticale Contrappeso 1:50

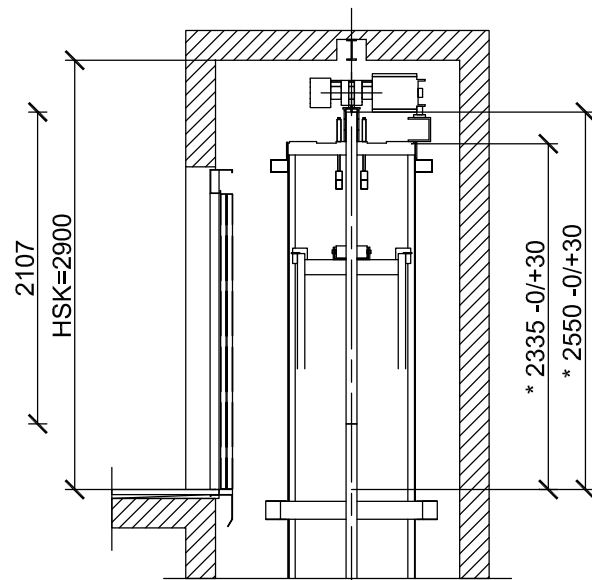

* = Lunghezza colonna guide da piano estremo superiore

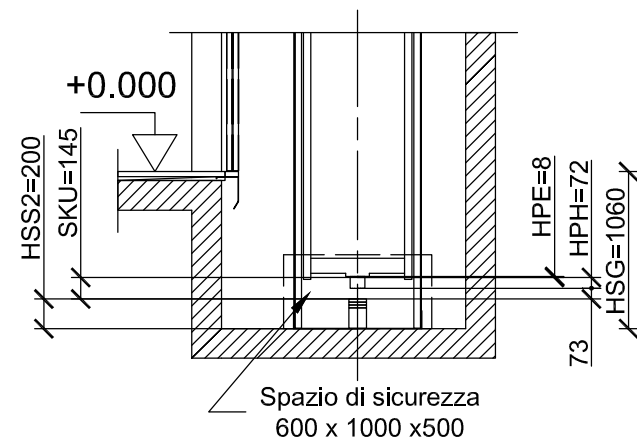

Sezione verticale Cabina 1:50

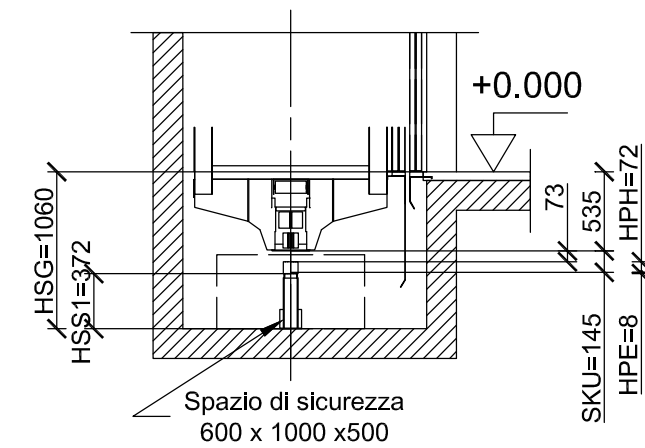
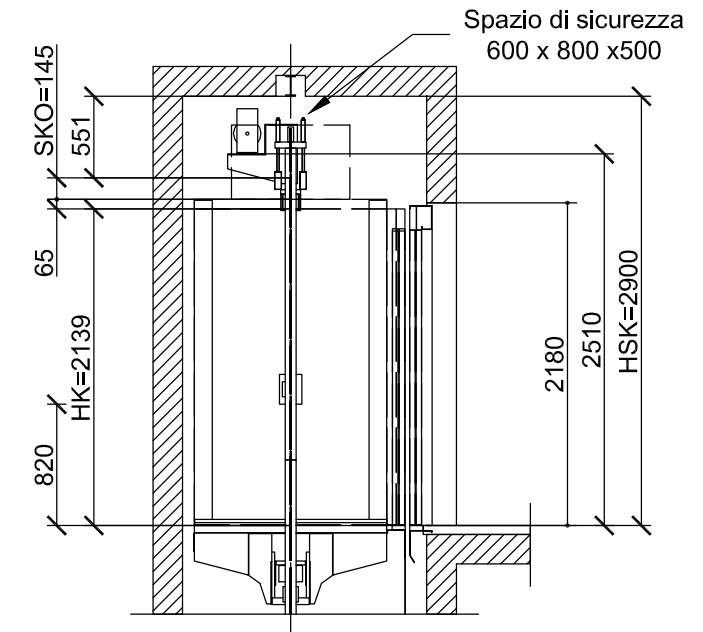

Master Dispo

Schindler 3300 / 5300

GQ (kg): 535
HSK (mm): 2900

Disegnato	R. Vigano'	22/02/2008	A3
Rilasciato			

Plan No.

GQ535HSK2900_Sezione verticale

